



Ambelt®

Conveyor belts and components

Ambelt® is your reliable partner for DIN standard conveyor belts and components for regionally, nationally and internationally operating vulcanizing and trading companies as well as plant manufacturers of the bulk material sector.

We provide our customers with rubber conveyor belts and wear protection material stocked in four national warehouses.

Ambelt® guarantees DIN-fabrication according to the strict ISO standards as well as high quality standards, technological competence and profound market experience.

On top, Ambelt® offers a wide product portfolio with regards to conveyor systems; i.e. rubber conveyor belts in diverse specifications, wear protection rubber sheets, pulley laggings, impact bars, rollers, pulleys as well as repair material.

Ambelt® index of products

Conveyor belts

Textile conveyor belts	06
Oil resistant conveyor belts	07
Sliding conveyor belts	07
Heat resistant conveyor belts	08
Flame-retardant conveyor belts	08
Chevron belts	09
RipStop/Breaker conveyor belts	16
Steel cord belts	17
Sidewall belts	18
Textile elevator belts	22
Steel cord elevator belts	22
PVC/PU light conveyor belts	22
Supergrip belts (Rough-Top)	23
FDA approved belts.....	23
Special conveyor belts	23

Wear protection & Pulley lagging

Ambelt® 45, 60 and 60 Super	26
Ambelt® Para and Para Super	27
Ambelt® Prema Super	28
Ambelt® Ceramic wear protection sheets	29
Ambelt® Pulley lagging	30

Conveyor components

Ambelt® Impact bars AmPact	32
Ambelt® Dust sealing	33
Ambelt® Skirting rubber	34
Sandwich rubber scrapers	35
Pulley scrapers	36
PU-pulley scrapers	36
Secondary scrapers (hard metal)	36
Drive pulleys	37
Return pulleys	37
Snub pulleys	37
Cleats	38
Sidewalls	39
Gurtec rollers, roller stations, brackets	40

Repair material

Ambelt® Permaflex	44
Helmitin® Cold bonding systems, steel primer, cleaner	46
Repair tapes	50
Repair sheets	50
Repair patches	51

Textile conveyor belts



Ambelt® textile conveyor belts made of EP or PP-textiles are used for conveying bulk material. Due to the high tensile strength and stability the belts are suitable for long distance conveyors. Ambelt® conveyor belts are strictly manufactured according to DIN 22102. The Ambelt® product portfolio includes diverse qualities and assemblies as well as cross rigid XE-fabric.

Application areas

- Mining industry
- Chemical sector
- Iron and steel industry
- Ports and transshipment operations
- Wood industry
- Coal-fired power plants
- Recycling industry
- Sand and gravel industry
- Stone quarries
- Cement plants

Belt model

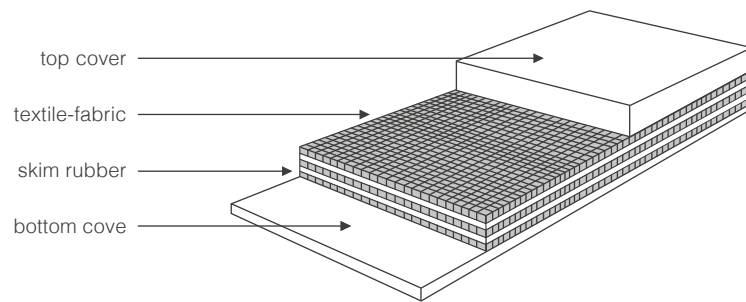

Technical Data

carcass	tensile strength (N/mm²)	textile layers	thickness of covers (in mm)		
			top	bottom	width
EP/PP	200	1 – 3	1 – 40	0 – 40	300 – 9.000
	250				
	315				
	400	2 – 6			
	500				
	630				
	800				
	1.000				
	1.250				
	1.500				
	1.600				
3.150					

Quality

	Y-quality	X-quality	Z-quality	N-quality	W-quality
tensile strength	≥ 20 N/mm²	≥ 24 N/mm²	≥ 15 N/mm²	≥ 16 N/mm²	≥ 18 N/mm²
abrasion	≤ 150 mm³	≤ 120 mm³	≤ 150 mm³	≤ 120 mm³	≤ 90 mm³
elongation at break	≥ 400%	≥ 450%	≥ 350%	≥ 400%	≥ 400%

Oil resistant conveyor belts



Grease, mineral oil and solvents may cause damages to normal textile conveyor belts. Even a short exposure to these substances may effect a swelling of the cover rubber. Therefore, Ambelt® offers oil resistant belts. The special rubber compound of the material reduces wear and increases the efficiency of the production. Ambelt's® product portfolio comprises the qualities MOR (medium oil resistant) and OR (oil resistant). The product specifications are also available in cross rigid XE-fabric. All belt widths up to 3.000mm are available from stock.

Application areas

- Chemical industry
- Fertilizer industry
- Iron and steel industry
- Feed industry
- Grain silo
- Glass industry
- Wood industry
- Metal processing industry
- Recycling industry

Technical data

	MOR-quality	OR-quality
tensile strength	≥ 14 N/mm²	≥ 12 N/mm²
abrasion	≤ 200 mm³	≤ 200 mm³
elongation at break	≥ 350%	≥ 300%

Sliding conveyor belts



Sliding conveyor belts are operated on sliding tables and are always used wherever conveyors do not work with a rolling structure for technical reasons. Ambelt® sliding belts are always manufactured according to DIN 22102. Compared to standard conveyor belts, they have a lower friction between the belt and the framework, since the bottom of the belt is made of smooth running textile instead of rubber. This minimizes the wear on the conveyor belt and increases customer efficiency. Ambelt® also provides this product in oil resistant belts and cross-rigid XE specification.

Application areas

- Airports
- Wood industry
- Food industry
- Parcel services
- Recycling plants
- Packaging industry

Heat resistant conveyor belts



Heat resistant conveyor belts are highly resistant to hot material such as cement, steel or sand. The cover rubber of a conveyor belt consists of a special rubber compound featuring high adhesive strength, elongation at break and excellent thermal protection force. Using diverse elastomers heat resistance varies.

Heat resistant Ambelt® conveyor belts manufactured according to DIN 22102 are able to convey material with a constant temperature of 200°C – short runs also up to 250°C.

Application areas

- Chemical sector
- Fertilizer industry
- Iron and steel industry
- Foundries
- Glass industry
- Metalworking industry
- Waste incineration
- Cement plants

 Also available as Breaker/RipStop version.

Technical Data

	Heat 150°	Heat 180°	Heat 220°
tensile strength	≥ 15 N/mm ²	≥ 12 N/mm ²	≥ 12 N/mm ²
abrasion	≤ 250 mm ³	≤ 250 mm ³	≤ 250 mm ³
elongation at break	≥ 350%	≥ 350%	≥ 350%
const. operating temp.	≤ 150°	≤ 180°	≤ 220°

Flame-retardant conveyor belts



One of the major risks during a production process is fire. Flame-retardant conveyor belts may therefore be used to reduce or even avert damages to persons and property in case of fire.

Application areas

- Mining industry
- Iron and steel industry
- Ports and transshipment operations
- Power plants
- Tunnel construction

Ambelt® provides you with the quality according to your demand

- K quality: flame-retardant with cover plate
- S quality: flame-retardant with or without cover plate
- V quality: self-extinguishing
- EN14973 Class A: underground mining / tunnel construction

Technical data

	K-quality	S-quality	V-quality	EN14973 Class A
tensile strength	≥ 20 N/mm ²	≥ 20 N/mm ²	≥ 17 N/mm ²	≥ 15 N/mm ²
abrasion	≤ 200 mm ³	≤ 200 mm ³	≤ 175 mm ³	≤ 200 mm ³
elongation at break	≥ 400%	≥ 400%	≥ 400%	≥ 350%

Chevron belts



For gradient angles of more than 18°, bulk material cannot be transported using ordinary textile conveyor belts. Chevron conveyor belts are used instead.

As there are many different application areas, flow rates and operational specifications Ambelt® provides an abundant portfolio of open and closed profile types. For individual client requests regarding the height or type of profile, tailor-made solutions can be realized.

 Ambelt® also provides chevron belts in RipStop/Breaker version, as well as in cross-rigid, heat resistant, flame-retardant and oil resistant quality.

Application areas

- Ports and transshipment operations
- Wood industry
- Smelteries
- Coal-fired power plants
- Coal industry
- Agriculture
- Recycling industry
- Sand and gravel industry
- Stone quarries
- Cement plants

Type V3, V5, V6 and V10

height of chevron (mm)	width of chevron (mm)	dist. betw. chev. (mm)	width of belt (mm)
Ambelt® chevron type V3			
3	600	100	600 – 800
Ambelt® chevron type V5			
5	620	100	620 – 820
5	300 – 1200	100	300 – 1200
Ambelt® chevron type V6			
6	500 – 1000	80	500 – 1200
6	500 – 1200	150	500 – 1200
6	650	100	650 – 900
6	1000	100	1000 – 1200
6	1200	100	1200 – 1600
Ambelt® chevron type V10			
10	600 – 1400	76	600 – 1400

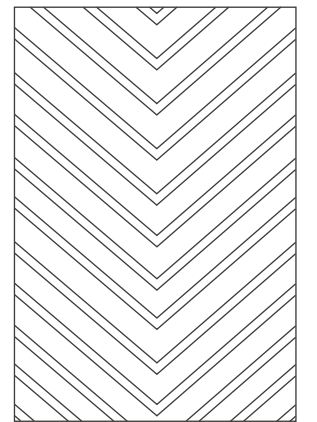

Type Multi-V6

height of chevron (mm)	width of chevron (mm)	dist. betw. chev. (mm)	width of belt (mm)
6	600 – 1400	76	600 - 1400

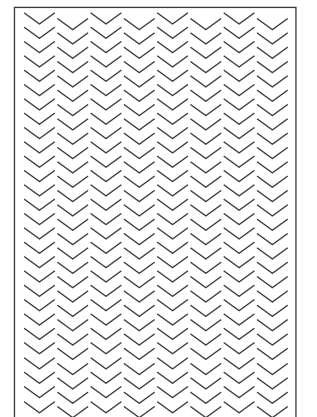

Chevron belts



Type V15 – standard open

height of chevron (mm)	width of chevron (mm)	dist. betw. chev. (mm)	width of belt (mm)
15	300	146	400 – 550
	380	250	450 – 850
	385	250	400 – 1000
	450	225	600 – 650
	600	328	700 – 1200
	600	250	650 – 1000
	750	250	800 - 1200

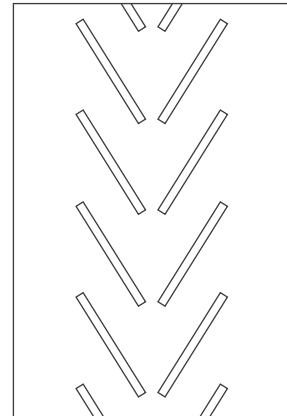

Type V15 – standard closed

height of chevron (mm)	width of chevron (mm)	dist. betw. chev. (mm)	width of belt (mm)
15	330	250	400 – 800
	450	300	500 - 1000

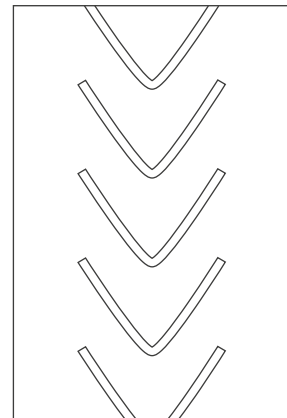

Type V15 – wide

height of chevron (mm)	width of chevron (mm)	dist. betw. chev. (mm)	width of belt (mm)
15	300 - 1200	125	300 - 1200

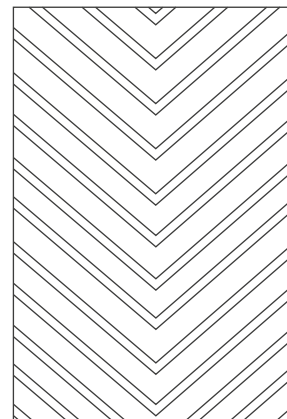

Chevron belts



Type C15 – standard

height of chevron (mm)	width of chevron (mm)	dist. betw. chev. (mm)	width of belt (mm)
15	500	340	550 - 800

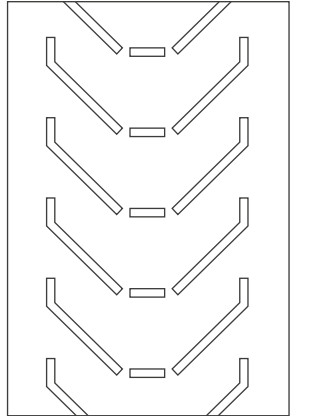

Type C15 – wide

height of chevron (mm)	width of chevron (mm)	dist. betw. chev. (mm)	width of belt (mm)
15	750	300	900 - 1000

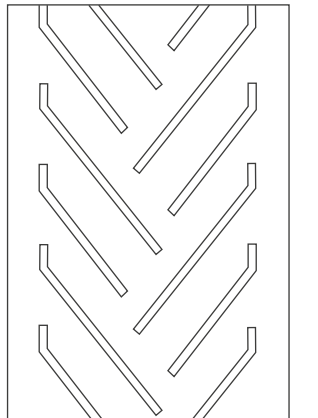

Type Y15 / 890

height of chevron (mm)	width of chevron (mm)	dist. betw. chev. (mm)	width of belt (mm)
15	890	190	1000 – 1500

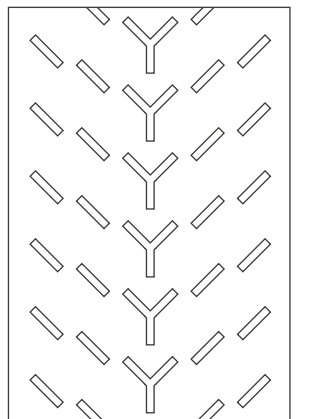

Chevron belts



Typ Y15 / 980

height of chevron (mm)	width of chevron (mm)	dist. betw. chev. (mm)	width of belt (mm)
15	980	190	1000 – 1500

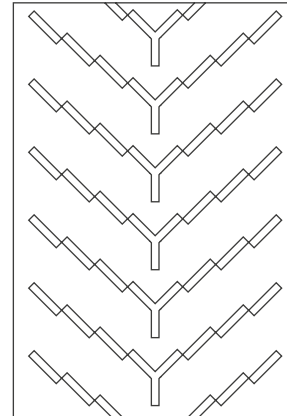

i Also available from stock as Breaker/RipStop version as well as including an edge strip.

Typ Y15 / 1090

height of chevron (mm)	width of chevron (mm)	dist. betw. chev. (mm)	width of belt (mm)
15	1090	190	1200 – 1400

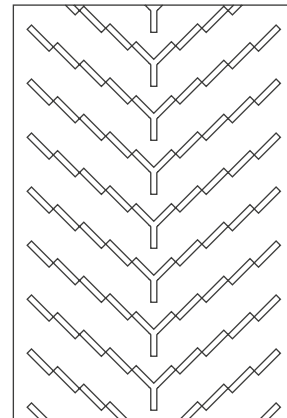

Typ Y15 / 1290

height of chevron (mm)	width of chevron (mm)	dist. betw. chev. (mm)	width of belt (mm)
15	1290	190	1400 – 1500

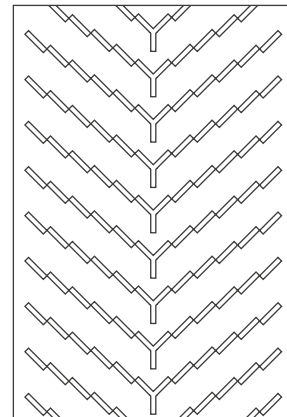

Chevron belts



Typ Y15 / 1700 or 1790

height of chevron (mm)	width of chevron (mm)	dist. betw. chev. (mm)	width of belt (mm)
15	1700 oder 1790	190	1800 – 2200

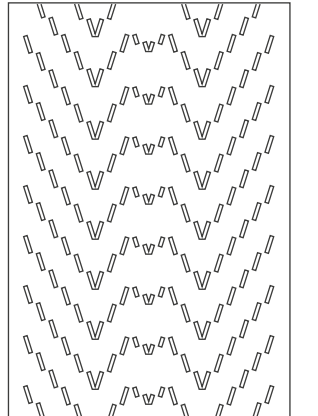

Typ Y17

height of chevron (mm)	width of chevron (mm)	dist. betw. chev. (mm)	width of belt (mm)
17	300	330	400 – 800

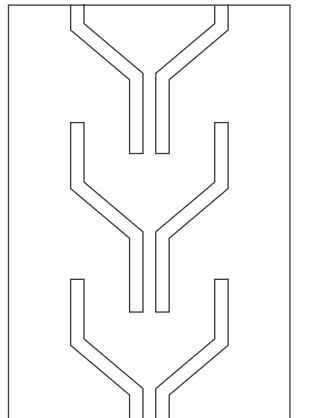

Typ Y17

height of chevron (mm)	width of chevron (mm)	dist. betw. chev. (mm)	width of belt (mm)
17	440	330	500 – 1000
	550	330	600 – 1000
	630	330	700 – 1000
	750	330	850 – 1200
	950	330	1050 - 1400

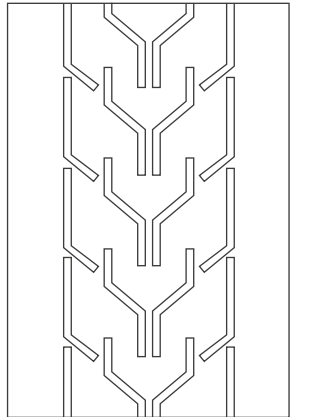

Chevron belts



Type C25

height of chevron (mm)	width of chevron (mm)	dist. betw. chev. (mm)	width of belt (mm)
25	450	330	500 – 1000
	550	330	600 – 1000
	750	330	850 – 1200

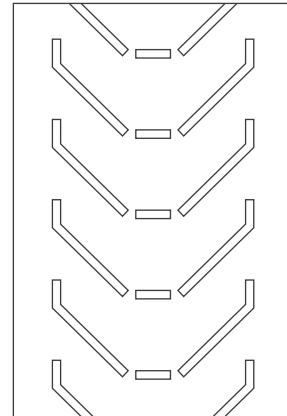

Type CT25

height of chevron (mm)	width of chevron (mm)	dist. betw. chev. (mm)	width of belt (mm)
25	450	250	500 – 800
	550	250	600 – 1200
	450	330	600 – 800
	550	330	600 – 800

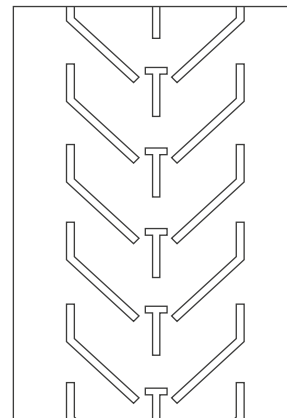

Type CL25

height of chevron (mm)	width of chevron (mm)	dist. betw. chev. (mm)	width of belt (mm)
25	1350 / 1365	500	1400

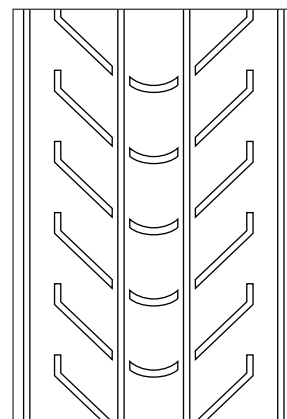

i Special version with Breaker/RipStop available from stock.

Chevron belts



Type C32 – slim

height of chevron (mm)	width of chevron (mm)	dist. betw. chev. (mm)	width of belt (mm)
32	460	330	550 - 1000

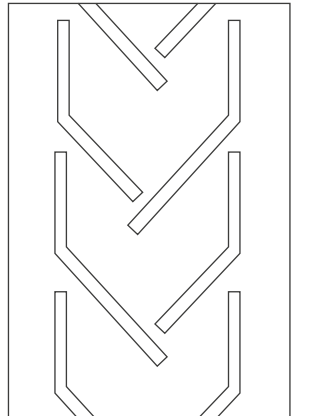

Type C32

height of chevron (mm)	width of chevron (mm)	dist. betw. chev. (mm)	width of belt (mm)
32	580	330	600 – 800
	630	330	650 – 900
	750	330	850 - 1400

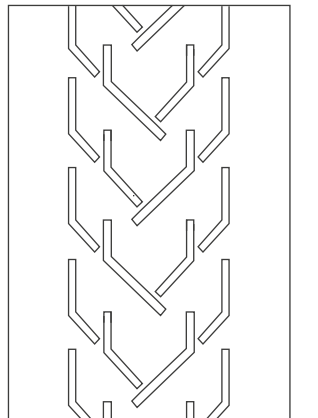

Type Y32

height of chevron (mm)	width of chevron (mm)	dist. betw. chev. (mm)	width of belt (mm)
32	450	255	500 – 800
	600	330	700 – 1000
	800	330	900 – 1200
	1365	330	1400 – 1600

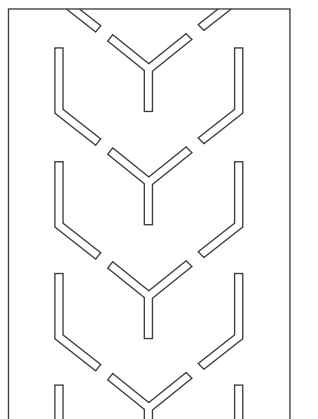

i Special version in 10:3 with Breaker/RipStop available from stock.

RipStop/Breaker conveyor belts



Sharp-edged goods and the impact of goods under unfavourable conditions may cause expensive longitudinal rips and breakthroughs in the belt. In order to avoid this, Ambelt® offers special steel breaker belts featuring a cutting protection layer (RipStop) on top of the textile carcass. Upon enquiry Ambelt® offers diverse types (i.e. textile breaker conveyor belts) and qualities.

Application areas

- Iron and steel industry
- Foundries
- Stone quarries
- Cement plants

Belt model

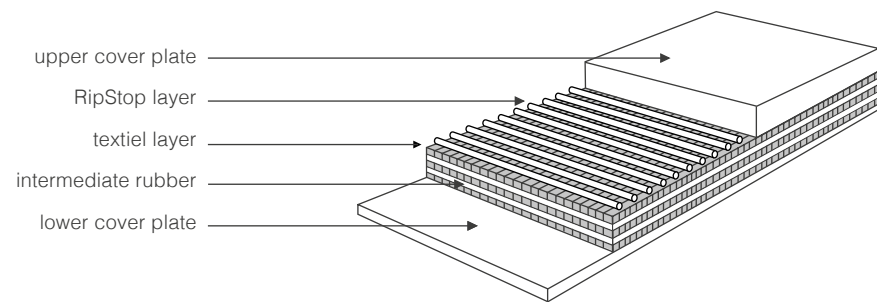

Technical data

conveyor belt type	textile type	tensile strength (N/mm ²)	number of textile layers	thickness upper and lower cover plate (mm)	cover quality	width on stock (mm)
steel breaker/ RipStop	EP	400 – 1350	3 – 6	5S + 3	X, Y, W, OR, MOR, K, V, S	up to 2400
				8S + 3		
				10S + 3		

i RipStop/Breaker conveyor belts are also available in cross-rigid and heat resistant quality.

Steel cord conveyor belts



Ambelt® steel cord conveyor belts are used to transport high volume flows over long distances. Thanks to the high tensile strength these belts are suitable for rough working conditions.

Ambelt® steel cord conveyor belts are strictly produced according to the DIN 22131 and ISO 15236 standards. The standard product portfolio comprises the qualities X, Y, K, V, HR150 and HR200.

Application areas

- Mining and salt extraction
- Iron and steel industry
- Ports and transshipment operations
- Coal mines
- Power plants
- Surface mining

Belt model

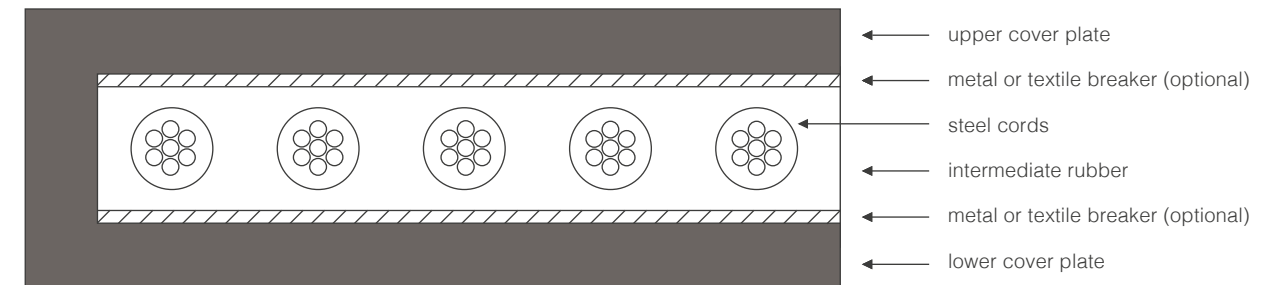

Technical data (other strength class on request)

	ST630	ST800	ST1000	ST1250	ST1600	ST1800	ST2000	ST2500	ST3150	ST3500	ST4000	ST4500	ST5000	ST5400
tensile strength (N/mm)	630	800	1000	1250	1600	1800	2000	2500	3150	3500	4000	4500	5000	5400
max. cord diameter (mm)	3,3	3,5	4,1	4,9	5,6	5,6	5,6	7,2	8,1	8,6	8,9	9,7	10,9	11,3
cord distance (mm) +- 1,5	13,5	13,5	12	14	15	13	12	15	15	15	15	16	17	17
minimum thickness of covers (mm)	4	4	4	4	6	6	6	8	8	8	8	8	8	8
width (mm) +- tolerance (mm) +-	number of steel cords													
500	5	36	36	40	34									
650	7	47	47	52	44									
800	8	58	58	64	55	50	58	62	50	50	50	50	46	43
1000	10	73	73	81	69	64	73	78	64	64	64	64	59	55
1200	10	87	87	97	84	77	88	97	77	77	77	77	71	66
1400	12	102	102	114	98	90	104	114	90	90	90	90	84	78
1600	12	117	117	131	112	104	120	131	104	104	104	104	96	90
1800	14	131	131	147	126	117	136	147	117	117	117	117	109	102
2000	14	146	146	164	141	130	150	164	130	130	130	130	121	113
2200	15	161	161	181	155	144	166	181	144	144	144	144	134	125
2400	15	175	175	197	169	157	182	197	157	157	157	157	146	137
2600	15			214	184	170	197	214	170	170	170	170	159	149
2800	15			231	198	184	213	231	184	184	184	184	171	161
3000	15			247	212	197	228	247	197	197	197	197	184	172
3200	15			264	227	210	243	264	210	210	210	210	196	184

Sidewall belts



Sidewall belts are suitable for horizontal to vertical transport (up to 90°) of bulk material. This can reduce the number of transfer points during operation and has a positive outcome in terms of producing in an energy and capital saving mode of operation. Ambelt® offers its customers a large portfolio of possible combinations of cleats and sidewalls in different height up to 500 mm.

Sidewalls and cleats may be manufactured with re-reinforced textile layers and connected with screws if required. Furthermore, Ambelt® offers sidewall conveyor belts in cross rigid XE design as well as with steel breaker.

For light to medium weight applications we recommend textile traverse reinforcement for the conveyor belts. For particularly high loads, conveyor belts with steel cable traverse reinforcement are the right choice.

Application areas

- Mining
- Iron and steel industry
- Foundries
- Port and handling
- Coal and biomass power plants
- Recycling industry
- Sand and gravel industry
- Stone quarries

Belt model

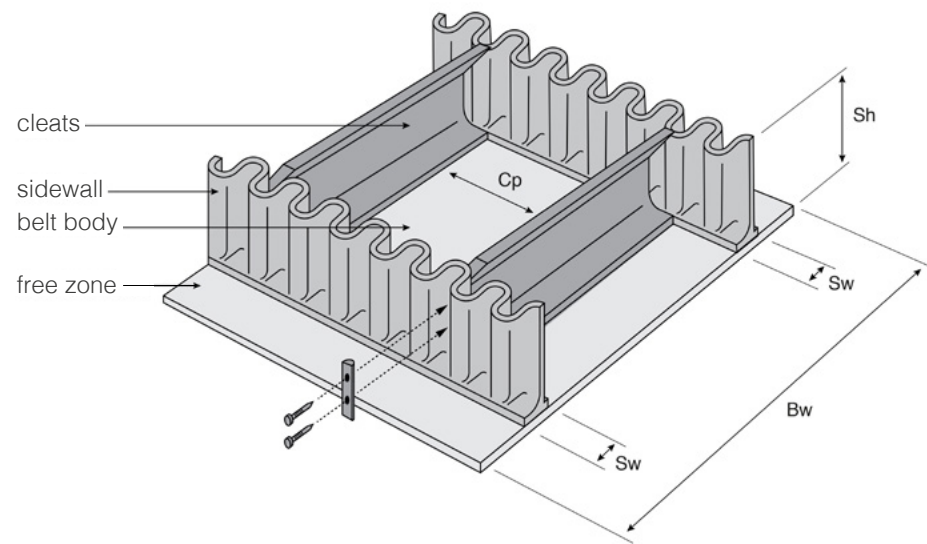

Sh = sidewall height
 Bw = belt width
 Cp = cleats pitch
 Sw = sidewall-foot width

Ambelt® supplies sidewall belts in the following rubber qualities:

- highly abrasion-resistant
- oil and fat resistant
- heat resistant
- flame retardant

i Because sidewall belts are always custom-made products, please contact the Ambelt® service team for receiving an individual offer that meets your requirements.

Sidewall belts



Overview

- hot vulcanisation of cleats and sidewalls on the base belt
- maximum cleat and sidewall height 500 mm
- maximum width of belt 4500 mm
- delivered as endless belt or open length

Technical data conveyor belt



	term	model	type	standard cover thickness*	min. pulley ø
	XE		250/2	4:2	200
			400/3	4:2	315
textile	XE+1		250/2+1	3:1,5	200
			315/2+1	4:2	250
			400/3+1		315
			500/3+1		400
	XE+2		400/3+2	4:2	315
			500/3+2		400
			630/4+2		500
			800/5+2	5:3	630
			1000/5+2		800
			1250/5+2		1000
	XE-SC+2		400/3+2	4:2	315
			500/3+2		400
			630/4+2		500
			800/5+2	5:3	630
			1000/5+2		800
			1250/5+2		1000
steel	XST-SC+2		1600	8:8	1250
			2000		
			2500		1400
			3150		

*other cover thicknesses available on clients request

Sidewall belts

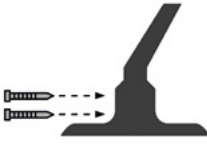

Technical data cleats

model	type	height (mm)	foot width (mm)
 C	C55	55	75
	C75	75	90
	C90	90	110
	C110	110	110
 T	T40	40	70
	T55	55	80
	T75	75	100
	T90	90	110
	T110	110	110
	T140	140	160
	T180	180	160
 TC	TC75	75	85
	TC90	90	110
	TC110	110	110
	TC140	140	150
	TC180	180	150
	TC230	230	160
	TC280	280	160
 TCS	TCS230	230	105
	TCS280	280	105
	TCS360	360	200
	TCS470	470	200

Sidewall belts



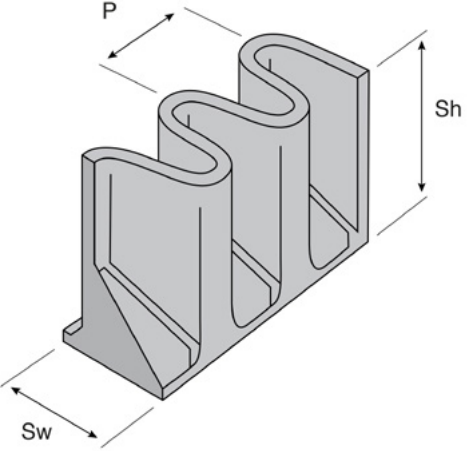

Technical data sidewall

model	type	height (Sh)	sidewall-foot width (Sw)	pitch (P)	weight (kg/m)
	standard	40	35	25	0,58
		40	50	40	1,03
		60			1,55
		80			1,82
		100			2,20
	120	2,65			
	textile reinforced	120	75	63,2	3,20
		160			4,76
		200			6,45
		240			7,50
250		6,37			
280		8,90			
HD	300	100	83	9,33	
	400			12,10	
	500			18,72	
					16,80

Belt steering wheels

For optimal belt alignment we recommend to use the Ambelt® belt steering wheels. The edge-free zone of the belt is located on or within the groove. This allows a reliable and gentle belt guidance.

Technical data

		outside diameter	300mm
		inside diameter	115mm
		total width	80mm
		groove width	50mm
		groove depth	40mm

Textile elevator belts



Elevator belts optimize transportation in limited spaces. Ambelt® elevator belts with EP-layers are produced according to strict regulations of the DIN22102 and DIN22104 standards. Elevator belts are highly qualified for upright conveyance of bulk material. Special designs according to customers' specifications may be realized any time. The elevator belts can be delivered ready-to-install including mechanical fasteners, bucket protection sheets as well as punched holes for bucket installation.

Application areas

- Iron foundries
- Coal-fired power plants
- Agriculture
- Food production
- Recycling industry
- Cement plants

Steel cord elevator belts



For high performance elevators such as in the cement industry, steel cord conveyor belts are used in diverse designs. Ambelt® is generally using heat and ageing resistant rubber compounds for their steel cord elevator belts.

Special designs according to customers' specifications may be realized any time. The elevator belts can be delivered ready-to-install including mechanical fasteners, bucket protection sheets as well as punched holes for bucket installation.

Application areas

- Coal-fired power plants
- Recycling industry
- Cement plants

PVC/PU light conveyor belts



Ambelt® light duty conveyor belts are generally used for short to medium transportation distances and allow transportation of bulk and pieces also in narrow production areas, e. g. in the food industry or in logistic centres.

We offer you a solution for almost every application area. The product portfolio comprises light conveyor belts made of PU, PVC and other material. According to your requirements with cleats and sidewalls – with or without textile layers as well as for oil resistant and FDA applications.

Application areas

- Glass industry
- Wood industry
- Food industry
- Logistic centres and parcel services
- Recycling industry
- Brick factories
- Sugar industry

Supergrip belts (Rough-Top)



Ambelt® Supergrip belts are manufactured with a special top cover surface having a structure which avoids slipping of the material transported on horizontal or inclining belts. These belts are available in normal but also as crossrigid XE design.

Application areas Supergrip belts

- Airports and Amusement parks
- Beverage industry
- Wood transport (e.g. wood chips)
- Parcel centres
- Passenger transportation

FDA approved belts



Ambelt® FDA approved belts are mainly used in the sugar and food industry but also in the colour and paint production.

Ambelt® is looking forward to advise you regarding the suitable belt according to your specifications and requirements.

Application areas FDA approved belts

- Sugar and food industry
- Paint and varnish production

Special conveyor belts



Ambelt® offers standard belts but also special belts according to customers' specifications. We are happy to provide you support for your technical enquiries.

Ambelt® 45, 60 and 60 Super



Ambelt® delivers a wide product range of different wear protection products.

Overview

- protects equipment and construction parts as well as components against wear
- Ambelt® offers wear resistant rubber sheets in different qualities and thickness of 2 - 50 mm
- on demand with or without contact layer, in rolls or cut to size, depending on individual requirements.
- customer specific colours, roll length and width available on short notice

Specification of Ambelt® standard wear protection

	unit	Ambelt® 45°	Ambelt® 60°	Ambelt® 60° Super
general information				
colour*		red	black	black
roll length*	m	10	10	10
roll width*	mm	1.500 / 2.000	2.000	2.000
elastomers				
polymers		NR	NR/SBR	NR/SBR
spec. weight	g/cm³	1,08	1,13	1,10
hardness	shore A	40° (+5°)	60° (+5°)	60° (+5°)
technical characteristics				
tensile strength	Kg/cm²	170	150	200
elongation at break	%	600	400	450
tear resistance	Kg/cm	60	60	55
abrasion	mm³ (at 5N)	< 85	< 140	< 80
operating temp.	°C	-30 until +70	-30 until +70	-30 until +70

 * Available in customer specific colours, roll length and width.

Ambelt® Para and Para Super



Ambelt® supplies wear protection rubber Para in two different qualities with or without contact layer.

Application examples

- Discharge hoses e.g. in the cement industry
- Compensators

Overview of advantages

- extra abrasion-resistance
- outstanding elongation at break values

Technical data

	unit	Para	Para Super
general information			
colour*		beige	caramel
roll length*	m	10	10
roll width*	mm	2.000	2.000
elastomers			
polymers		NR	NR
spec. weight	g/cm³	1,2	0,97
hardness	Shore A	45°	35°
technical characteristics			
tensile strength	Kg/cm²	150	150
elongation at break	%	550	800
tear resistance	Kg/cm	18	25
abrasion	mm³ (bei 5N)	< 125	< 95
operating temp.	°C	-30 until +70	-30 until +70

 * Available in customer specific colours, roll length and width.

Ambelt® Prema Super



Ambelt® Prema Super is a wear protection rubber of highest quality. It features a high elongation at break and tear resistance as well as an excellent weather resistance. Ambelt® Prema Super is available with or without contact layer.

Technical data

	unit	Ambelt® Prema Super
general information		
colour*		yellow
roll length*	m	10
roll width*	mm	2.000
elastomers		
polymers		NR
spec. weight	g/cm ³	1,00
hardness	shore A	35°
technical characteristics		
tensile strength	Kg/cm ²	190
elongation at break	%	650
tear resistance	Kg/cm	34
abrasion	mm ³	< 95
operating temp.	°C	-30 until +70

 * Available in customer specific colours, roll length and width.

Ambelt® Ceramic wear protection sheets



Mosaic ceramic lagging offers a very efficient wear protection for light to medium stress application areas.

The ceramic sheets must be buttjoined and on bigger areas they need to be staggered. Minimal abrasion allows extended lifecycle. The structure of the contact layer, the rubber back and the ceramic mosaic reduce noise emission during operation.

At standard areas aluminum oxide ceramic with a purity of 92% is applied. The backside of the Ambelt® ceramic lagging sheets is supplied with a special contact layer which facilitates fitting significantly. Ambelt® recommends Helmitin® cold bonding systems to ensure best interplay of products.

Ambelt® ceramic wear protection lagging sheets are available on stock in the measure 500 x 500 x 8 (4+4) mm. We will be glad to also manufacture to our customers' requirements deviating rubber or ceramic thickness.

Application examples

- Bunkers
- Drains
- Chutes
- Cyclones

Technical data

	unit	standard
measure of lagging sheet	mm	500x500
mosaic ceramic	mm	20x20
ceramic thickness	mm	4
total thickness	mm	8
hardness of rubber	shore A	60°

Ambelt® Pulley lagging



Rubber laggings are used for drive elements to ensure high friction and therefore to minimize slipping of the belt as well as to ensure straight run of the belt during operation.

Ambelt® Pulley lagging consists of high-quality synthetic rubber compounds which makes it first choice for excellent wear and corrosion protection. Furthermore Ambelt® Pulley lagging is supplied with a special contact layer on one side to ensure durable adhesion on the steel surface of the pulley. We recommend Helmitin® cold bonding systems to ensure best interplay of products.

Ambelt® Pulley lagging is available on stock in the measurements 2,000 mm x 10,000 mm and in the thickness 8, 10 and 12 mm. Available in customer specific thickness and colours upon request.

Ambelt® offers the following pulley lagging qualities:

- Oil resistant
- Red / Blue / White
- FDA
- Ceramic
- Corundum coating

Technical data

name / colour	type	polymers	spec. weight g/cm ³	hardness +5° shore A	tensile strength N/mm ²	elongation %	abrasion mm ³	contact layer	width mm
pulley lagging black 65	mini diamond / maxi diamond	SBR	1,15	65	14	400	< 120	with CN	1.400 1.800 2.000
pulley lagging black 60 oil	mini diamond	NR/SBR	1,19	60	15	400	< 150	with CN	
pulley lagging red 40	mini diamond	NR/SBR	1,17	40	20	600	< 120	with CN	
pulley lagging blue 50	mini diamond	NR/SBR	1,17	50	10	400	< 160	with CN	
pulley lagging white 60 L + oil	mini diamond	NBR	1,20	63	6	350	< 160	with CN	
pulley lagging white 60 FDA + oil	mini diamond	NBR	1,18	60	8	350	< 160	with CN	
ceramic	12 x 385 or 500 x 10.000 mm	SBR / ceramic	–	60	20	200	–	with CN	385 or 500
corundum coating	14 x 480 x 1900 mm	SBR / corundum	–	60	–	–	–	with CN	480

Ambelt® Impact bars AmPact



Dust, sharp objects or heavy bulk – conveyor belts are exposed to steady tackles in the loading area. The effect can be a poor guidance of the belt, costly repairs, long downtimes and productivity loss. To avoid those inconveniences and to increase the belt's lifecycle substantially, Ambelt® recommends to install their durable impact bars in the conveying systems.

Ambelt® impact bars feature a high level of workmanship and consist of an energy-efficient PE layer with low friction, an impact-absorbing rubber core as well as an aluminium profile for easy installation.

Ambelt® also delivers the appropriate bolts, washers and nuts in the sizes M16 and M12.

AmPact model

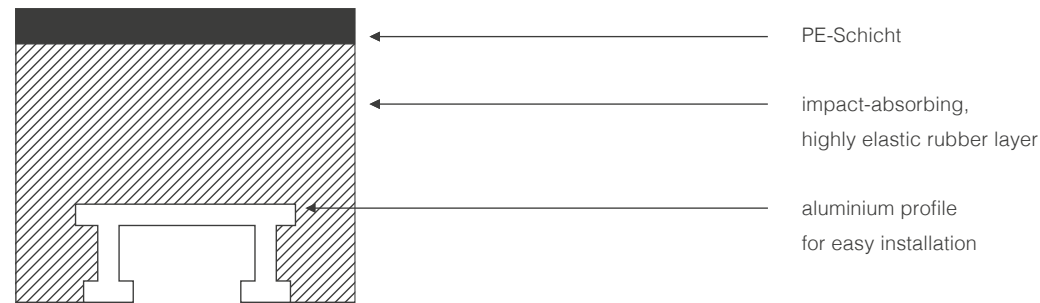

The following types are directly available on stock

AmPact 50	B x H x L: 100 x 50 x 1220 mm
AmPact 75	B x H x L: 100 x 75 x 1220 mm
AmPact 100	B x H x L: 100 x 100 x 1220 mm
AmPact 50 XL	B x H x L: 100 x 50 x 1500 mm
AmPact 75 XL	B x H x L: 100 x 75 x 1500 mm
AmPact 100 XL	B x H x L: 100 x 100 x 1500 mm

Ambelt® Dust sealing

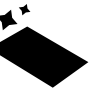

Ambelt® dust sealing protects your equipment from dust and dirt. No matter if screening machines, feeding trays or slides, this extra-light, flexible and elastic product may serve you to run your production flow smoothly and more economically. Ambelt® dust sealing does not only protect from dust and dirt but also reduces noise effectively.

Overview of advantages

- protects conveyor systems from dust and dirt at transition points
- reduces noise emissions
- your choice: normal or heat resistant quality

Technical data

	unit	standard	heat resistant
general information			
colour*	–	black	black
roll length*	m	20	20
roll width*	mm	1.400	1.400
elastomers			
polymers		NR	EPDM
spec. weight	g/cm³	1,00 (+/- 0,03)	1,11
hardness	shore A	40° (+/- 5°)	35°
technical characteristics			
tensile strength	Kg/cm²	150	90
elongation at break	%	550	750
tear resistance	Kg/cm	22	24
abrasion	mm³	< 85	< 95
operating temp.	°C	-30 until +70	-30 until +120

i * Available in customer specific colours, roll length and width.

Ambelt® Skirting rubber

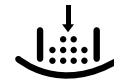

Skirting rubber is used for tranquilizing the material and for sealing the feeding point. The skirting rubber avoids the drop-down of material in the system periphery.

Ambelt® skirting rubber is offered in rolls in various colours and qualities and is available in the thickness 5 mm to 30 mm and in the height 60 mm to 200 mm. Ambelt® Extra is our premium quality for extreme operating conditions.

Technical data

	unit	red	black
general information			
colour*	–	red	black
roll length*	m	20	20
elastomers			
polymers		NR	NR
spec. weight.	g/cm³	1,20	1,27
hardness	Shore A	45°	65°
technical characteristics			
tensile strength	Kg/cm²	150	100
elongation at break	%	550	350
tear resistance	Kg/cm	29	17
abrasion	mm³	< 125	< 210
operating temp.	°C	-30 until +70	-30 until +70

 * Available in customer specific colours, roll length and width.

Ambelt® Sandwich rubber scrapers



For material easy to scrape and for lower belt speed a sandwich rubber scraper is recommended for economic reasons. Sandwich rubber scrapers are made of rubber in the combination hard - soft - hard (65°- 47°- 65° shore).

The exterior surface is made of 65° shore rubber having the hardness to clean the belt, the soft 47° shore core implies the necessary elasticity to endure vibrations.

Common rubber scrapers are directly available from stock in the thickness 15mm, 20mm and 30mm. We are happy to manufacture further measures upon request.

Technical data

	unit	black / green / black		black / red / black	
colour		black	green	black	red
elastomers					
polymers		NR/BR	NR	NR/BR	NR
spec. weight	g/cm³	1,13	1,07	1,13	1,07
hardness	shore A	60°	45°	60°	45°
technical characteristics					
tensile strength	Kp/cm²	150	200	150	200
elongation at break	%	400	600	400	600
abrasion	mm³	< 140 (10N)	< 80 (5N)	< 140 (10N)	< 80 (5N)
operating temp.	°C	-30 until +70	-30 until +70	-30 until +70	-30 until +70

Scrapers



Scrapers serve for the general cleaning of the belt. By installing scrapers you may avoid the sticking of material at your belt surface and increase the lifecycle of your belt remarkably. Furthermore, the pollution of the equipment is reduced to a minimum.

Application areas

- Asphalt mixing plants
- Plaster and cement plants
- Glass industry
- Recycling industry
- Sand and gravel industry
- Stone quarries
- Brick factories

Pulley scrapers

- application at light to medium-heavy and especially for high endurance conveyor belt systems
- suitable for crowned drums
- high flexibility due to PU and hard metal segments
- also suitable for reverse operations
- belt speed up to 5m/s
- especially for very sticky material or difficult and confined spaces

PU-pulley scrapers

- high-quality PU segments for extraordinary high endurance
- suitable for crowned drums and for reverse operations
- high cleaning performance due to flexible PU segments
- belt speed up to 5m/s
- especially for badly damaged belt surfaces and PVC belts
- extra-suitable for confined spaces thanks to compact design

Secondary scrapers (hard metal)

- the Ambelt® standard belt scraper is used for light to strong pollutions of the conveyor belt
- flexible installation possibilities
- special low installation height

Drive pulleys



Drive pulleys guide the engine power via the transmission into the drum and via friction into the belt, while also guiding the conveyor belt from the upper run to the lower run.

Ambelt® sells particularly robust and easy-to-maintain drive pulleys to ensure the longevity of your conveying system. The specification of the drive pulley depends on several parameters such as the area of application, the amount of material being transported, the running speed of the belt and the belt specification. The Ambelt® team will be happy to advise you on the right selection of the drive pulley.

Return pulleys



Return pulleys guide the belt from the lower run to the upper run, and don't have any driving function.

Ambelt® sells particularly robust and easy-to-maintain return pulleys to ensure the longevity of your conveying system. The specification of the return pulley depends on several parameters such as the area of application, the amount of material being transported, the running speed of the belt and the belt specification. The Ambelt® team will be happy to advise you on the right selection of the return pulley.

Snub pulleys



Snub pulleys are conveying system components that are individually designed and manufactured in different sizes and for different conveying requirements.

Snub pulleys are used to increase the wrap angle of the conveyor belt to reduce the pulling force of the belt. Snub pulleys can therefore optimise the cost of your conveying system, since they reduce the belt tension which means that a conveyor belt with a lower belt strength can be used for the same purpose.





To improve the friction between the drum and the belt and to increase the wear protection, Ambelt® recommends to coat the drive pulley. Depending on the application, either rubber, ceramic or PU are recommended as coating material, which are also part of the Ambelt® product portfolio.

Cleats



Ambelt® offers different types of cleats (C, T, TC, TCS, B) as well as different heights (20 - 470 mm) for multi-faceted applications.

Technical data cleats

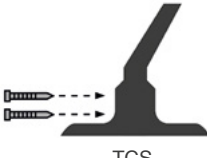
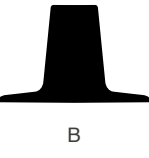
model	type	height (mm)	foot width (mm)
 C	C55	55	75
	C75	75	90
	C90	90	110
	C110	110	110
 T	T40	40	70
	T55	55	80
	T75	75	100
	T90	90	110
	T110	110	110
	T140	140	160
	T180	180	160
 TC	TC75	75	85
	TC90	90	110
	TC110	110	110
	TC140	140	150
	TC180	180	150
	TC230	230	160
 TCS	TC280	280	160
	TCS230	230	105
	TCS280	280	105
	TCS360	360	200
 B	TCS470	470	200
	B20	20	55
	B25	25	35
	B30	30	80
	B40	40	80
	B60	60	80
	B75	75	80
	B110	110	110
	B140	140	140

Sidewalls



To increase the conveying volume of the belt, sidewalls are often vulcanised to each side of the conveyor belt. These sidewalls are exposed to high forces – in the transverse direction the sidewalls have to carry the weight of the conveyed material, while in the longitudinal direction the sidewalls are stretched and compressed, in particular at the deflection area. Because of this Ambelt® sidewalls are characterized by a wear-resistant and highly flexible rubber quality. Depending on the application, conveying capacity and customer requirements, Ambelt® offers different heights of sidewalls (40 mm to 500 mm in height) as well as fabric reinforced sidewalls. Ambelt® recommends a fabric insert for any sidewalls higher than 140mm. If the sidewalls need to be screwed to the cleats, a fabric insert becomes necessary.

Ambelt® offers the following pulley lagging qualities:

- standard
- oil resistant
- acid resistant
- flame retardant
- heat resistant

Technical data sidewall

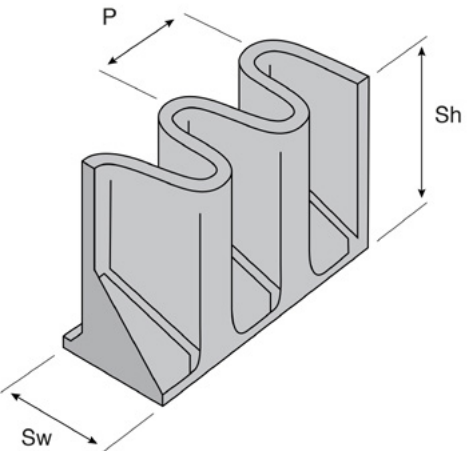
model	type	height (Sh)	sidewall-foot width (Sw)	pitch (P)	weight (kg/m)
	standard	40	35	25	0,58
		40	50	40	1,03
		60			1,55
		80			1,82
		100			2,20
	120	2,65			
	textile reinforced	120	75	63,2	3,20
		160			4,76
		200			6,45
		240			7,50
250		6,37			
280		8,90			
HD	300	100	83	9,33	
	400			12,10	
	500			18,72	
					16,80

Gurtec rollers, roller stations, brackets



Ambelt® delivers rollers by Gurtec in all variations and dimensions for various applications. Furthermore, Ambelt® offers roller stations with height of 60 and 100 mm and brackets. Standard products are always available on stock.

Roller model

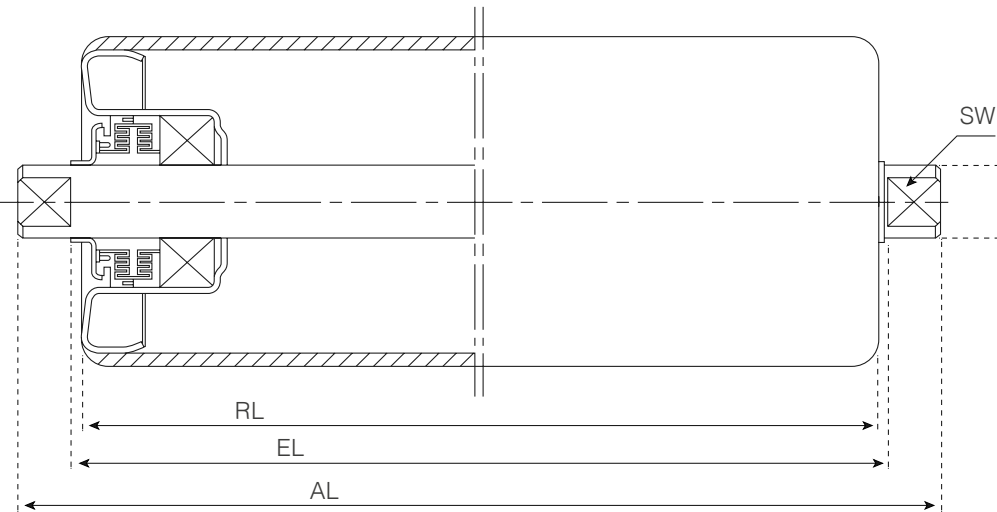

Gurtec rollers



Technical data roller type 6204

Ø	categorization of belt width (mm)			measure (mm)			axis end	mass (kg)	
	3 tlg	2 tlg	1 tlg	RL	EL	AL	SW	dreh. Teile	gesamt
63,5*1,75	500			200	206	226	15/10	0,92	1,56
	650	400		250	256	276	15/10	1,06	1,82
	800	500		315	321	341	15/10	1,23	2,15
	1000	650		380	386	406	15/10	1,40	2,48
	1200	800		465	471	491	15/10	1,63	2,92
			400	500	506	532	15/13	1,72	3,11
	1600	1000	500	600	606	632	15/13	1,99	3,63
	2000		650	750	756	782	15/13	2,25	4,14
			800	950	956	982	15/13	2,92	5,42
			1000	1150	1156	1182	15/13	3,45	6,45
88,9*2,9	500			200	206	226	15/10	1,77	2,41
	650	400		250	256	276	15/10	2,08	2,84
	650	400		250	256	276	14/10	2,08	2,84
	800	500		315	321	341	15/10	2,48	3,40
	800	500		315	321	341	14/10	2,48	3,40
	1000	650		380	386	406	15/10	2,88	3,96
	1200	800		465	471	491	15/10	3,40	4,69
			400	500	506	532	15/13	3,62	5,00
	1400			530	536	556	15/10	3,80	5,27
	1600	1000	500	600	606	632	15/13	4,23	5,87
108*3,25	500		xx	200	206	226	15/10	2,32	2,96
	650	400	xx	250	256	276	15/10	2,74	3,50
	800	500	xx	315	321	341	15/10	3,28	4,20
	1000	650	xx	380	386	406	15/10	3,83	4,91
	1200	800	xx	465	471	491	15/10	4,54	5,83
	1600	1000	500	600	606	632	15/13	5,68	7,31
	2000		650	750	756	782	15/13	6,93	8,94
			800	950	956	982	15/13	8,61	11,11
			1000	1150	1156	1182	15/13	10,29	13,28

i * exemplary table, further specifications upon request

Ambelt® Permaflex



Ambelt® Permaflex is universally applicable and suitable for the repair of conveyor belts, rubber coating and linings as well as sealing of gaps. Breakthroughs and longitudinal cracks may for example be repaired up to any length. Ambelt® Permaflex consists of a two-component polyurethane and features a fast processing time. After 30 minutes the processed spot may be ground or re-worked. There are two different ways of application depending on the intended purpose: Either by hand or with the help of a spray system.

Overview

- suitable for repair of conveyor belts, rubber coatings, linings and sealing of gaps
- two-components polyurethane system
- short processing time
- fast, clean and flexible
- dry to the touch after 2 minutes
- may be ground and re-worked after 30 minutes
- free of any volatile substances
- shock-resistant, highly resistant to abrasion
- maximum hardness of 60° shore A
- processing by hand or with the help of a spray system

Technical data

colour	black
elastomere	polyurethane
tensile strength	≥ 400%
hardness	60 shore A
abrasion	≤ 120 mm³
elongation at break	1629 PSI

Range of products

Ambelt Permaflex mechanical spray gun	200 ml
Ambelt Permaflex double cartridge	200 x 200 ml
Ambelt Permaflex mixing cannula	200 ml
Ambelt Permaflex pneumatic spray gun	750 ml
Ambelt Permaflex double cartridge	750 x 750 ml
Ambelt Permaflex mixing cannula	750 ml
Ambelt Permaflex special Primer	125 ml bottle
Ambelt Permaflex special Primer	250 ml bottle

Ambelt® Permaflex



Application steps



1. Thoroughly clean the working surface



2. Roughen the working surface



3. Prepare with specific PF-84 Primer



4. Remove the buckle and fasten the mixing tip



5. Place the cartridge in the spray gun



6. Apply Permaflex repair material

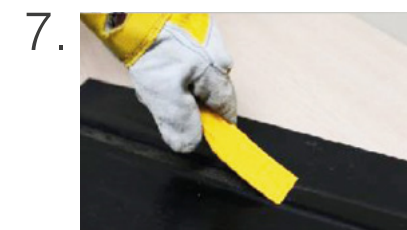

7. Spackle if necessary



8. Spot may be re-worked after 30 minutes

Helmitin® Cold bonding systems, steel primer, cleaner

Ambelt® is international sales partner (for Germany, Austria, Switzerland and Eastern Europe) for Helmitin® bonding systems, steel primer and cleaner. Ambelt® offers the entire product family of Helmitin® cold bonding systems; e.g. Helmitin® 14030. This glue system is an absolute highlight as the applied solvent is non-flammable but nevertheless trichloroethylene-free.

Technical data	Helmitin® 14030	Helmitin® 14026
base	polychloroprene	polychloroprene
colour	black	black
viscosity	approx. 3700 mPas	approx. 3500 mPas
density	approx. 1.42 g/cm ³	approx. 0.85 g/cm ³
hardener additive	5% Swift® hardener (9502)	5% Swift® hardener (9503)
pot life	approx. 3 hours	approx. 1-3 hours
manner of application	filler, paintbrush	filler, paintbrush
consumption	300 – 400 g/m ²	300 – 400 g/m ²
airing time	10 – 15 minutes	10 – 15 minutes
contact bonding time	approx. 30 minutes	approx. 30 minutes
setting time	approx. 24 hours	approx. 24 hours
permitted storage time	approx. 12 months	approx. 12 months
storage and transport conditions	well closed at temp. not below 10 °C	well closed at temp. not below 10 °C
sensitivity to cold	yes, defrostable	yes, defrostable
flammability	no, hardly combustible	combustible

In cooperation with:



Helmitin® Cold bonding systems, steel primer, cleaner

Stock goods – for rubber conveyor belts and steel linings.

Technical data

product type	product	properties	article no.	container
adhesive	Helmitin® 14030	hardly flammable, trichloroethylene-free	33-050-00001-100	1 kg can
			33-050-00003-100	3 kg can
	Helmitin® 14026	Flammable, with benzine	33-050-00001-300	0,6 kg can
			33-050-00002-300	2,5 kg can
	Swift® col 9254 Black	Highly flammable, thinner: Helmitin® 676/2	33-010-00900-001	15 kg can
	Swift®hardener 49502	hardly flammable, for Helmitin® 14030	33-050-00001-400	50 g bottle
33-050-00002-400			150 g bottle	
33-050-00001-402			30 g bottle	
hardener	Swift®hardener 49503	flammable, for Helmitin® 14026	33-050-00001-401	50 g bottle
			33-050-00002-401	150 g bottle
primer	Swift®prime 2903	metal primer	33-050-00001-500	0,7 kg can
cleaner / thinner	Helmitin® 676/2	flammable, trichloroethylene-free	33-050-00004-600	4 kg can
	Swiftclean 9041	hardly flammable, thinner & cleaner	33-050-00006-100	6 kg can

In cooperation with:



Helmitin® Cold bonding systems, steel primer, cleaner

Product overview – for rubber conveyor belts and steel linings

Adhesives / Primers

product	application				hardener (5%)		properties		
	belt manufacturing		lining of steel rollers	lining of tanks	Swift® hardener 9502	Swift® hardener 9503	hardly flammable	highly flammable	other properties
	sidewall	belt							
Helmitin® 14030	✓	✓	✓	✓	✓		✓		Good processability at low temperatures. Toluene and trichloroethylene free. Suitable to be used underground.
Helmitin® 14026	✓	✓	✓		✓	✓		✓	High initial and final bonding strength. Toluene free.
Helmitin® 14031	✓	✓	✓					✓	Easy to process at low temperatures. Very high initial bonding strength. Toluene free.
Swift® prime 2903			✓	✓					Very good adhesion to roughened steel. Good combination with above mentioned adhesives. Toluene free.
Swift® col 9254 black								✓	Very good adhesion of EPDM profiles on cement. Toluene free.

Thinners / Cleaners

product	used for				properties		
	Helmitin® 14030	Helmitin® 14026	Helmitin® 14031	Swift® col 9254 black	hardly flammable	highly flammable	other properties
Swift® clean 9041	✓				✓		Suitable to be used in mining. Free of trichloroethylene.
Helmitin® 676/2		✓	✓	✓		✓	Free of toluene and chlorinated hydrocarbons.

In cooperation with:



Helmitin® Cold bonding systems, steel primer, cleaner

Product overview – for PVC/PU conveyor belts and power transmission belts

Adhesives / Primers

product type	product	hardener (5%)			properties
		Helmitin® 49631	Helmitin® 500 FB	Härter F1	
adhesive	Helmitin® 3530/18	✓	✓	✓	Good penetration due to low viscosity. Low activation temperature. Very good tack.
adhesive	Helmitin® 3113/05	✓	✓	✓	High initial bonding strength.
adhesive	Helmitin® GPV	✓	✓	✓	Low viscosity. Very high initial bonding strength. Very high heat resistance.
primer	Helmitin® 3114/05	✓	✓	✓	Low viscous primer for highly absorbent materials.
primer	Helmitin® 15208	✓	✓	✓	Primer for polyurethane and PVC materials.
primer	Helmitin® T/FL	–	–	–	One-part halogenating primer for the preparation of rubber materials.

Thinners / Cleaners

product	used for					application
	Helmitin® 3530/18	„Helmitin® 3113/05“	„Helmitin® 3114/05“	„Helmitin® GPV“	Helmitin® 15208	
Helmitin® 694	✓	✓	✓	✓	✓	Washing of PVC and polyurethane.

In cooperation with:



Repair tapes



Technical data

product	type	width (mm)	thickness (mm)	length (m)	packing unit
repair tape – RB	without textile layer	35	1,7	10	1 roll
		50	1,7		
		70	2,2		
		100	2,2		
		150	3,2		
		220	3,2		
		300	3,2		
repair tape – RBG	with textile layer	100	3,6	10	1 roll
		150	4,6		
		220	4,6		
		300	4,8		

Repair sheets



Technical data

product	width (mm)	thickness (mm)	length (m)	packing unit
repair compensation plate – RP	500	1,5	10	1 roll
		2		
		3		
		4		
repair compensation plate – RA/2VKS	500	0,5	10	1 roll
		1,5		
		3		

Repair patches



Technical data

product	type	dimensions (mm)	thickness (mm)	packing unit
repair patch round shape – RUF	without textile layer	ø 120	3	5
repair patch diamond shape – RAF	without textile layer	160 x 130	2,3	5
		250 x 200	2,3	5
		380 x 270	2,3	5
repair patch diamond shape – RAFG	with textile layer	160 x 130	3,7	5
		250 x 200	3,7	5
repair patch rectangle shape – REF	without textile layer	100 x 240	2,3	10
		220 x 320	2,3	10
		300 x 500	2,3	10
repair patch rectangle shape – REFG	with textile layer	100 x 240	3,7	10
		220 x 320	3,7	10
		300 x 500	3,7	10

Imprint

Ambelt® conveyor belts is a registered trademark of:



Quaddro Group GmbH
Kreuztor 2
38126 Braunschweig

Tel.: +49 (0) 531 609 440 211
Fax.: +49 (0) 531 180 544 57
E-Mail: info@ambelt.de
www.ambelt.de

Year of foundation: 1995